

Data Sheet



Article number: 604132024030

Description: Taper bored timing belt pulley
HTD 24 8M 30 TL 1108

Measures

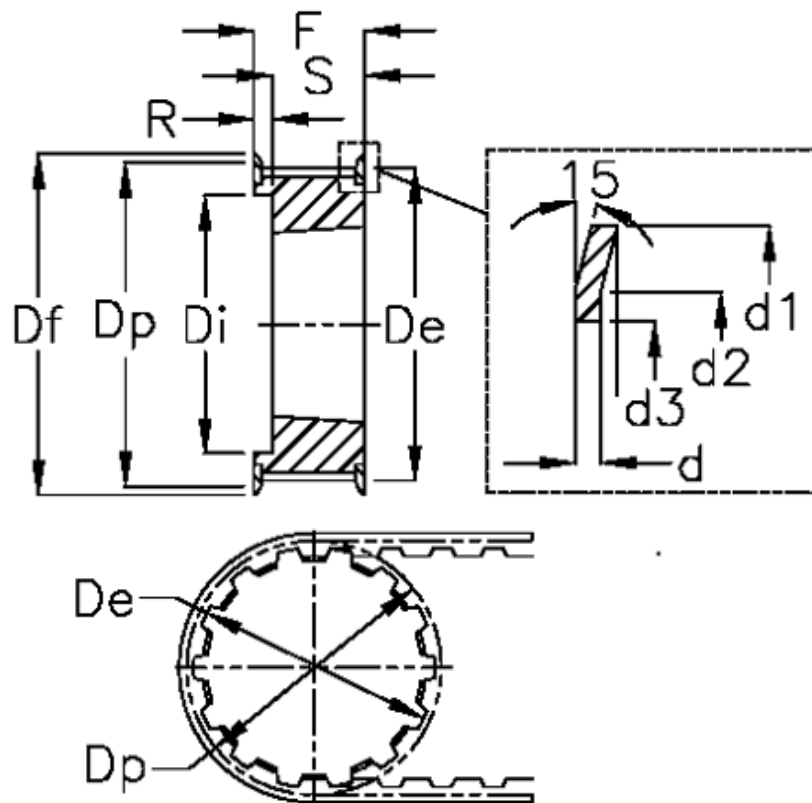

d = 1.5	F = 38	Weight = 0.38
d1 = 66	Flange type = F25	Width = 30
d2 = 63	For bushing = 1108	
d3 = 52	Max bore = 25	
De = 59.75	r = 16	
Df = 66	S = 22	
Di = 44	Tooth number = 24	
Dp = 61.12	Type = 8M	